

RACCORDERIA PER ALA GOCCIOLANTE “POLY”

“POLY” DRIPLINE FITTINGS

PER TUBI IN PE DI SPESSORE DA 0.75 A 1.40 MM (DA 30 A 55 MIL) / FOR PE PIPES WITH THICKNESS FROM 0.75 TO 1.40 MM (FROM 30 TO 55 MIL)

CARATTERISTICHE TECNICHE TECHNICAL FEATURES

MATERIALI IMPIEGATI / RAW MATERIALS

PP + anti-UV

FILETTATURE / THREADS

UNI EN 10226
(ex ISO 7/1)

Per tubi in PE di spessore da 0.75 a 1.40 mm (da 30 a 55 mil)
For PE pipes with thickness from 0.75 to 1.40 mm (from 30 to 55 mil)

I dati del presente catalogo, hanno titolo puramente indicativo e non sono vincolanti. La Plast Project S.r.l. si riserva il diritto, anche senza preavviso, di effettuare modifiche ai prodotti, ai fini del loro miglioramento tecnico.

The specifications in this document are to be considered merely informative and are not binding. Plast Project S.r.l. reserves its right to carry out all the modifications which are considered necessary in accordance with technical improvement.

RACCORDERIA PER ALA GOCCIOLANTE "POLY"

"POLY" DRIPLINE FITTINGS

PER TUBI IN PE DI SPESSORE DA 0.75 A 1.40 MM (DA 30 A 55 MIL) / FOR PE PIPES WITH THICKNESS FROM 0.75 TO 1.40 MM (FROM 30 TO 55 MIL)

3410

CODE	Ø	LT	F	D	LO	LA	FG
3410.0160	16-16	83.2	9.9	16.0	8.0	35.8	16.3
3410.0180	18-18	83.2	11.8	18.0	8.0	37.8	18.3
3410.0200	20-20	85.1	14.0	20.0	8.0	40.8	21.0
3410.0220	22-22	87.1	17.6	23.5	8.0	45.5	24.3

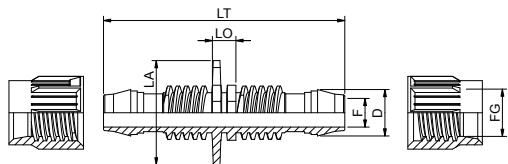

3412

CODE	Ø	LT	F	D	FR	DR	LO	LA	FG	FGR
3412.1816	18-16	83.2	11.8	18.0	9.9	16.0	8.0	37.8	18.3	16.3
3412.2016	20-16	84.1	14.0	20.0	9.9	16.0	8.0	40.8	21.0	16.3
3412.2018	20-18	84.1	14.0	20.0	11.8	18.0	8.0	40.8	21.0	18.3
3412.2216	22-16	85.1	17.6	23.5	9.9	16.0	8.0	45.5	24.3	16.3
3412.2218	22-18	85.1	17.6	23.5	11.8	18.0	8.0	45.5	24.3	18.3
3412.2220	22-20	86.1	17.6	23.5	14.0	20.0	8.0	45.5	24.3	21.0

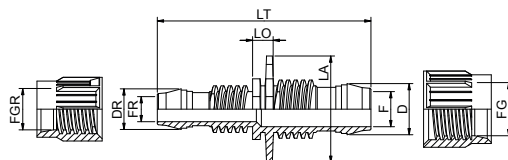

3414

CODE	Ø	LT	F	D	FF	DF	LF	LO	FG
3414.016C	16-1/2"	60.7	9.9	16.0	14.0	1/2"	15.3	8.0	16.3
3414.016D	16-3/4"	64.6	9.9	16.0	18.3	3/4"	17.3	10.0	16.3
3414.018C	18-1/2"	60.7	11.8	18.0	14.0	1/2"	15.3	8.0	18.3
3414.018D	18-3/4"	60.7	11.8	18.0	18.3	3/4"	17.3	10.0	18.3
3414.020C	20-1/2"	61.7	14.0	20.0	14.0	1/2"	15.3	8.0	21.0
3414.020D	20-3/4"	65.6	14.0	20.0	18.3	3/4"	17.3	10.0	21.0
3414.022C	22-1/2"	62.7	17.6	23.5	14.0	1/2"	15.3	8.0	24.3
3414.022D	22-3/4"	66.6	17.6	23.5	18.3	3/4"	17.3	10.0	24.3

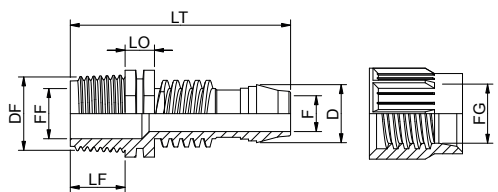

3422

CODE	Ø	LT	F	D	FD	DC	DT	LO	LA	FG
3422.0160	16-D	61.5	9.9	16.0	8.9	14.0	16.8	8.0	35.8	16.3
3422.0180	18-D	61.5	11.8	18.0	8.9	14.0	16.8	8.0	37.8	18.3
3422.0200	20-D	62.5	14.0	20.0	8.9	14.0	16.8	8.0	40.8	21.0
3422.0220	22-D	63.5	17.6	23.5	8.9	14.0	16.8	8.0	45.5	24.3

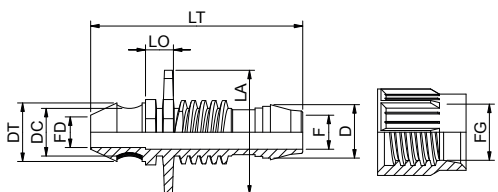

RACCORDERIA PER ALA GOCCIOLANTE "POLY"

"POLY" DRIPLINE FITTINGS

PER TUBI IN PE DI SPESSORE DA 0.75 A 1.40 MM (DA 30 A 55 MIL) / FOR PE PIPES WITH THICKNESS FROM 0.75 TO 1.40 MM (FROM 30 TO 55 MIL)

3424

CODE	Ø	LT	F	D	FD	DC	DT	LO	LA	FG
3424.0200	20-DXL	65.8	14.0	20.0	14.0	19.0	21.8	8.0	40.8	21.0
3424.0220	22-DXL	66.8	17.6	23.5	14.0	19.0	21.8	8.0	45.5	24.3

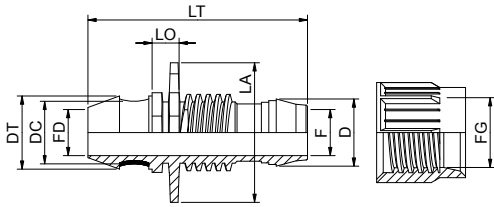

3425

CODE	Ø	LT	F	D	FD	DG	DT	LO	LA	FG
3425.0160	16-D	63.6	9.9	16.0	8.9	11.8	14.0	8.0	35.8	16.3
3425.0180	18-D	63.6	11.8	18.0	8.9	11.8	14.0	8.0	37.8	18.3
3425.0200	20-D	64.6	14.0	20.0	8.9	11.8	14.0	8.0	40.8	21.0
3425.0220	22-D	65.6	17.6	23.5	8.9	11.8	14.0	8.0	45.5	24.3

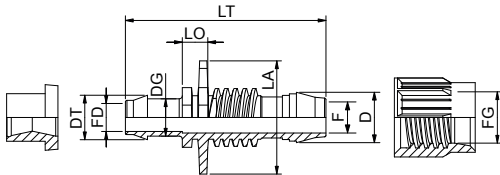

3426

CODE	Ø	LT	F	D	FD	DG	DT	LF	LO	LA	FG
3426.0160	16-D	79.6	9.9	16.0	7.9	11.4	14.0	14.0	8.0	35.8	16.3
3426.0180	18-D	79.6	11.8	18.0	7.9	11.4	14.0	14.0	8.0	37.8	18.3
3426.0200	20-D	80.6	14.0	20.0	7.9	11.4	14.0	14.0	8.0	40.8	21.0
3426.0220	22-D	81.6	17.6	23.5	7.9	11.4	14.0	14.0	8.0	45.5	24.3

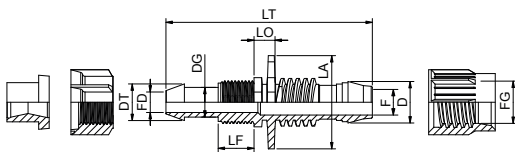

3428

CODE	Ø	LT	F	D	DF	DE	LF	LO	LV	FG
3428.0160	16-D	65.9	9.9	16.0	3/8"	24.3	19.3	10.0	49.6	16.3
3428.0180	18-D	65.9	11.8	18.0	3/8"	24.3	19.3	10.0	49.6	18.3
3428.0200	20-D	66.9	14.0	20.0	3/8"	24.3	19.3	10.0	49.6	21.0
3428.0220	22-D	67.9	17.6	23.5	3/8"	24.3	19.3	10.0	49.6	24.3

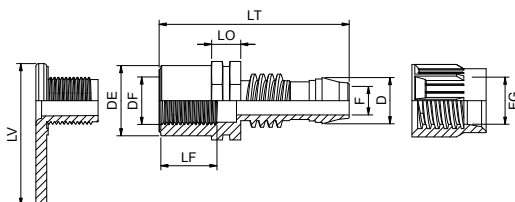

RACCORDERIA PER ALA GOCCIOLANTE "POLY"

"POLY" DRIPLINE FITTINGS

PER TUBI IN PE DI SPESSORE DA 0.75 A 1.40 MM (DA 30 A 55 MIL) / FOR PE PIPES WITH THICKNESS FROM 0.75 TO 1.40 MM (FROM 30 TO 55 MIL)

3430

CODE	Ø	LT	F	D	DF	DE	LV	DG	LG	FG
3430.0160	16-D	65.9	9.9	16.0	3/4"	29.3	49.6	30.0	21.2	16.3

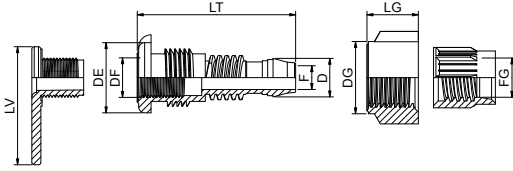

3432

CODE	Ø	LT	F	D	LO	LA	FG
3432.0160	16	47.5	9.9	16.0	8.0	35.8	16.3
3432.0180	18	47.5	11.8	18.0	8.0	37.8	18.3
3432.0200	20	48.5	14.0	20.0	8.0	40.8	21.0
3432.0220	22	49.5	17.6	23.5	8.0	45.5	24.3

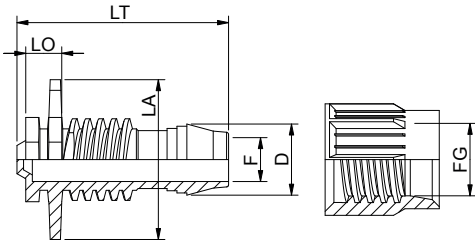

3434

CODE	Ø	LT	F	D	F1	D1	D2	LO	LA	FG
3434.1616	16-16	73.3	9.9	16.0	9.8	14.8	15.6	8.0	35.8	16.3
3434.1618	16-18	73.3	11.8	18.0	9.8	14.8	15.6	8.0	37.8	18.3
3434.1620	16-20	74.3	14.0	20.0	9.8	14.8	15.6	8.0	40.8	21.0
3434.1622	16-22	75.3	17.6	23.5	9.8	14.8	15.6	8.0	45.5	24.3
3434.2016	20-16	73.6	9.9	16.0	13.9	19.0	20.0	8.0	35.8	16.3
3434.2018	20-18	73.6	11.8	18.0	13.9	19.0	20.0	8.0	37.8	18.3
3434.2020	20-20	74.6	14.0	20.0	13.9	19.0	20.0	8.0	40.8	21.0
3434.2022	20-22	75.6	17.6	23.5	13.9	19.0	20.0	8.0	45.5	24.3
3434.2516	25-16	80.8	9.9	16.0	18.2	24.0	25.0	3.5		16.3
3434.2518	25-18	80.8	11.8	18.0	18.2	24.0	25.0	3.5		18.3
3434.2520	25-20	81.8	14.0	20.0	18.2	24.0	25.0	3.5		21.0
3434.2522	25-22	82.8	17.6	23.5	18.2	24.0	25.0	8.0	45.5	24.3

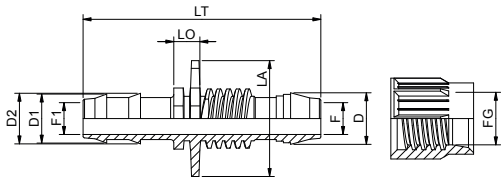

3436

CODE	Ø	LT	F	D	F1	D1	D2	LO	LA	FG	FG1
3436.1616	16-16	77.9	9.9	16.0	10.0	14.2	15.0	8.0	35.8	16.3	16.7
3436.1618	16-18	77.9	11.8	18.0	10.0	14.2	15.0	8.0	37.8	18.3	16.7
3436.1620	16-20	78.9	14.0	20.0	10.0	14.2	15.0	8.0	40.8	21.0	16.7
3436.1622	16-22	79.9	17.6	23.5	10.0	14.2	15.0	8.0	45.5	24.3	16.7
3436.2016	20-16	79.6	9.9	16.0	14.0	18.3	19.1	8.0	35.8	16.3	20.7
3436.2018	20-18	79.6	11.8	18.0	14.0	18.3	19.1	8.0	37.8	18.3	20.7
3436.2020	20-20	80.6	14.0	20.0	14.0	18.3	19.1	8.0	40.8	21.0	20.7
3436.2022	20-22	81.6	17.6	23.5	14.0	18.3	19.1	8.0	45.5	24.3	20.7
3436.2516	25-16	83.7	9.9	16.0	18.3	23.1	23.9	10.0		16.3	25.7
3436.2518	25-18	83.7	11.8	18.0	18.3	23.1	23.9	10.0		18.3	25.7
3436.2520	25-20	84.7	14.0	20.0	18.3	23.1	23.9	10.0		21.0	25.7
3436.2522	25-22	83.7	17.6	23.5	18.3	23.1	23.9	8.0	45.5	24.3	25.7

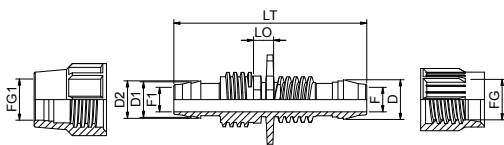

RACCORDERIA PER ALA GOCCIOLANTE "POLY"

"POLY" DRIPLINE FITTINGS

PER TUBI IN PE DI SPESSORE DA 0.75 A 1.40 MM (DA 30 A 55 MIL) / FOR PE PIPES WITH THICKNESS FROM 0.75 TO 1.40 MM (FROM 30 TO 55 MIL)

3450

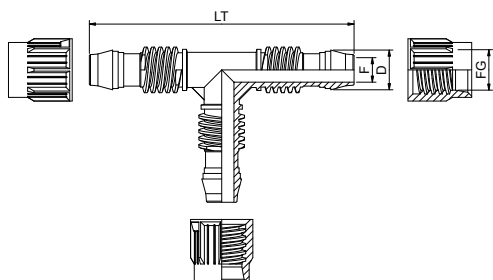

CODE	Ø	LT	F	D	FG
3450.0160	16-16-16	106.9	9.9	16.0	16.3
3450.0180	18-18-18	106.9	11.8	18.0	18.3
3450.0200	20-20-20	108.9	14.0	20.0	21.0
3450.0220	22-22-22	110.9	17.6	23.5	24.3

3452

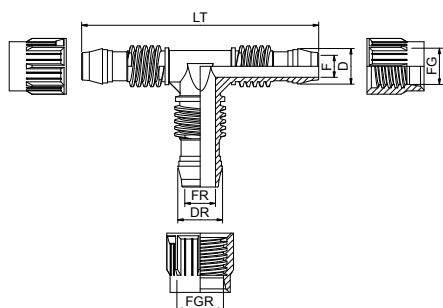

CODE	Ø	LT	F	D	FR	DR	FG	FGR
3452.1618	18-16-18	106.9	11.8	18.0	9.9	16.0	18.3	16.3
3452.1620	20-16-20	108.9	14.0	20.0	9.9	16.0	21.0	16.3
3452.1622	22-16-22	110.9	17.6	23.5	9.9	16.0	24.3	16.3
3452.1816	16-18-16	106.9	9.9	16.0	11.8	18.0	16.3	18.3
3452.1820	20-18-20	108.9	14.0	20.0	11.8	18.0	21.0	18.3
3452.1822	22-18-22	110.9	17.6	23.5	11.8	18.0	24.3	18.3
3452.2016	16-20-16	106.9	9.9	16.0	14.0	20.0	16.3	21.0
3452.2018	18-20-18	106.9	11.8	18.0	14.0	20.0	18.3	21.0
3452.2022	22-20-22	110.9	17.6	23.5	14.0	20.0	24.3	21.0

3454

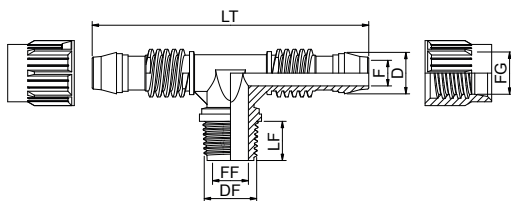

CODE	Ø	LT	F	D	FF	DF	LF	FG
3454.016C	16-1/2"-16	106.9	9.9	16.0	14.0	1/2"	15.3	16.3
3454.016D	16-3/4"-16	106.9	9.9	16.0	18.3	3/4"	17.3	16.3
3454.018C	18-1/2"-18	106.9	11.8	18.0	14.0	1/2"	15.3	18.3
3454.018D	18-3/4"-18	106.9	11.8	18.0	18.3	3/4"	17.3	18.3
3454.020C	20-1/2"-20	108.9	14.0	20.0	14.0	1/2"	15.3	21.0
3454.020D	20-3/4"-20	108.9	14.0	20.0	18.3	3/4"	17.3	21.0
3454.022C	22-1/2"-22	110.9	17.6	23.5	14.0	1/2"	15.3	24.3
3454.022D	22-3/4"-22	110.9	17.6	23.5	18.3	3/4"	17.3	24.3

3460

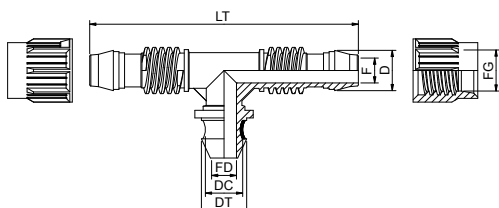

CODE	Ø	LT	F	D	FD	DC	DT	FG
3460.0160	16-D-16	106.9	9.9	16.0	8.9	14.0	16.8	16.3
3460.0180	18-D-18	106.9	11.8	18.0	8.9	14.0	16.8	18.3
3460.0200	20-D-20	108.9	14.0	20.0	8.9	14.0	16.8	21.0
3460.0220	22-D-22	110.9	17.6	23.5	8.9	14.0	16.8	24.3

RACCORDERIA PER ALA GOCCIOLANTE "POLY"

"POLY" DRIPLINE FITTINGS

PER TUBI IN PE DI SPESSORE DA 0.75 A 1.40 MM (DA 30 A 55 MIL) / FOR PE PIPES WITH THICKNESS FROM 0.75 TO 1.40 MM (FROM 30 TO 55 MIL)

3462

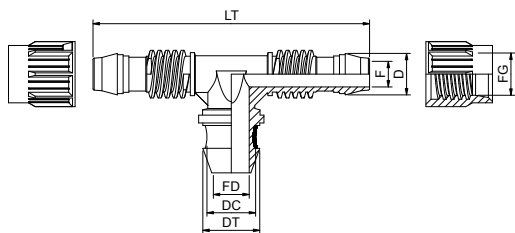

CODE	Ø	LT	F	D	FD	DC	DT	FG
3462.0160	16-DXL-16	106.9	9.9	16.0	14.0	19.0	21.8	16.3
3462.0180	18-DXL-18	106.9	11.8	18.0	14.0	19.0	21.8	18.3
3462.0200	20-DXL-20	108.9	14.0	20.0	14.0	19.0	21.8	21.0
3462.0220	22-DXL-22	110.9	17.6	23.5	14.0	19.0	21.8	24.3

3468

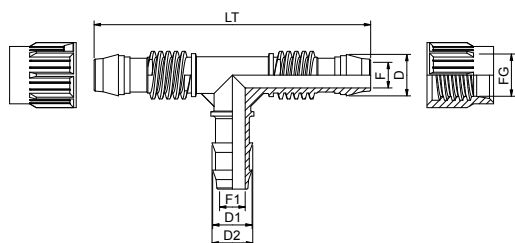

CODE	Ø	LT	F	D	F1	D1	D2	FG
3468.1616	16-16-16	106.9	9.9	16.0	9.8	14.8	15.6	16.3
3468.1618	18-16-18	106.9	11.8	18.0	9.8	14.8	15.6	18.3
3468.1620	20-16-20	108.9	14.0	20.0	9.8	14.8	15.6	21.0
3468.1622	22-16-22	110.9	17.6	23.5	9.8	14.8	15.6	24.3
3468.2016	16-20-16	106.9	9.9	16.0	13.9	19.0	20.0	16.3
3468.2018	18-20-18	106.9	11.8	18.0	13.9	19.0	20.0	18.3
3468.2020	20-20-20	108.9	14.0	20.0	13.9	19.0	20.0	21.0
3468.2022	22-20-22	110.9	17.6	23.5	13.9	19.0	20.0	24.3
3468.2516	16-25-16	106.9	9.9	16.0	18.2	24.0	25.0	16.3
3468.2518	18-25-18	106.9	11.8	18.0	18.2	24.0	25.0	18.3
3468.2520	20-25-20	108.9	14.0	20.0	18.2	24.0	25.0	21.0
3468.2522	22-25-22	110.9	17.6	23.5	18.2	24.0	25.0	24.3

3470

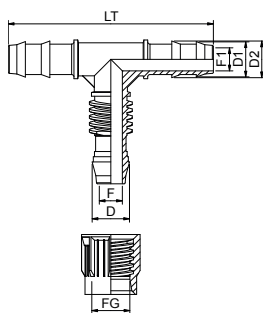

CODE	Ø	LT	F	D	F1	D1	D2	FG
3470.1616	16-16-16	87.3	9.9	16.0	9.8	14.8	15.6	16.3
3470.1620	20-16-20	87.9	9.9	16.0	13.9	19.0	20.0	16.3
3470.1625	25-16-25	102.1	9.9	16.0	18.2	24.0	25.0	16.3
3470.1816	16-18-16	87.3	11.8	18.0	9.8	14.8	15.6	18.3
3470.1820	20-18-20	87.9	11.8	18.0	13.9	19.0	20.0	18.3
3470.1825	25-18-25	102.1	11.8	18.0	18.2	24.0	25.0	18.3
3470.2016	16-20-16	87.3	14.0	20.0	9.8	14.8	15.6	21.0
3470.2020	20-20-20	87.9	14.0	20.0	13.9	19.0	20.0	21.0
3470.2025	25-20-25	102.1	14.0	20.0	18.2	24.0	25.0	21.0
3470.2216	16-22-16	87.3	17.6	23.5	9.8	14.8	15.6	24.3
3470.2220	20-22-20	87.9	17.6	23.5	13.9	19.0	20.0	24.3
3470.2225	25-22-25	102.1	17.6	23.5	18.2	24.0	25.0	24.3

3472

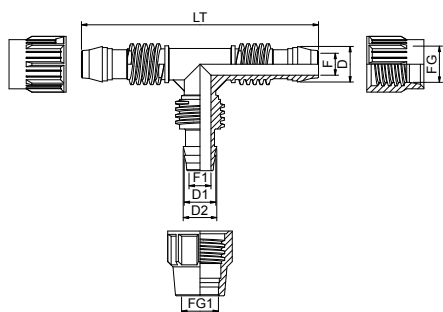

CODE	Ø	LT	F	D	F1	D1	D2	FG	FG1
3472.1616	16-16-16	106.9	9.9	16.0	10.0	14.2	15.0	16.3	16.7
3472.1618	18-16-18	106.9	11.8	18.0	10.0	14.2	15.0	18.3	16.7
3472.1620	20-16-20	108.9	14.0	20.0	10.0	14.2	15.0	21.0	16.7
3472.1622	22-16-22	110.9	17.6	23.5	10.0	14.2	15.0	24.3	16.7
3472.2016	16-20-16	106.9	9.9	16.0	14.0	18.3	19.1	16.3	20.7
3472.2018	18-20-18	106.9	11.8	18.0	14.0	18.3	19.1	18.3	20.7
3472.2020	20-20-20	108.9	14.0	20.0	14.0	18.3	19.1	21.0	20.7
3472.2022	22-20-22	110.9	17.6	23.5	14.0	18.3	19.1	24.3	20.7
3472.2516	16-25-16	106.9	9.9	16.0	18.3	23.1	23.9	16.3	25.7
3472.2518	18-25-18	106.9	11.8	18.0	18.3	23.1	23.9	18.3	25.7
3472.2520	20-25-20	108.9	14.0	20.0	18.3	23.1	23.9	21.0	25.7
3472.2522	22-25-22	110.9	17.6	23.5	18.3	23.1	23.9	24.3	25.7

RACCORDERIA PER ALA GOCCIOLANTE "POLY"

"POLY" DRIPLINE FITTINGS

PER TUBI IN PE DI SPESSORE DA 0.75 A 1.40 MM (DA 30 A 55 MIL) / FOR PE PIPES WITH THICKNESS FROM 0.75 TO 1.40 MM (FROM 30 TO 55 MIL)

3474

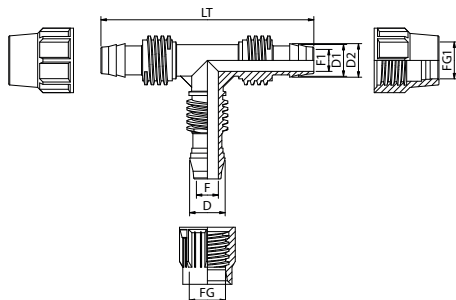

CODE	Ø	LT	F	D	F1	D1	D2	FG	FG1
3474.1616	16-16-16	96.0	9.9	16.0	10.0	14.2	15.0	16.3	16.7
3474.1620	20-16-20	99.2	9.9	16.0	14.0	18.3	19.1	16.3	20.7
3474.1625	25-16-25	102.9	9.9	16.0	18.3	23.1	23.9	16.3	25.7
3474.1816	16-18-16	96.0	11.8	18.0	10.0	14.2	15.0	18.3	16.7
3474.1820	20-18-20	99.2	11.8	18.0	14.0	18.3	19.1	18.3	20.7
3474.1825	25-18-25	102.9	11.8	18.0	18.3	23.1	23.9	18.3	25.7
3474.2016	16-20-16	96.0	14.0	20.0	10.0	14.2	15.0	21.0	16.7
3474.2020	20-20-20	99.2	14.0	20.0	14.0	18.3	19.1	21.0	20.7
3474.2025	25-20-25	102.9	14.0	20.0	18.3	23.1	23.9	21.0	25.7
3474.2216	16-22-16	96.0	17.6	23.5	10.0	14.2	15.0	24.3	16.7
3474.2220	20-22-20	99.2	17.6	23.5	14.0	18.3	19.1	24.3	20.7
3474.2225	25-22-25	102.9	17.6	23.5	18.3	23.1	23.9	24.3	25.7

3480

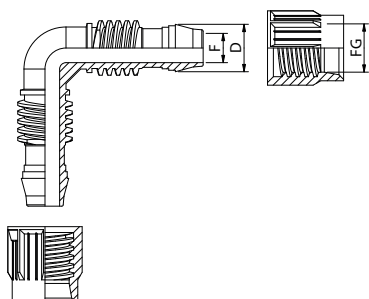

CODE	Ø	F	D	FG
3480.0160	16-16	9.9	16.0	16.3
3480.0180	18-18	11.8	18.0	18.3
3480.0200	20-20	14.0	20.0	21.0
3480.0220	22-22	17.6	23.5	24.3

3482

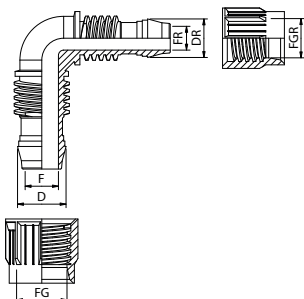

CODE	Ø	F	D	FG	FR	DR	FGR
3482.1816	18-16	11.8	18.0	18.3	9.9	16.0	16.3
3482.2016	20-16	14.0	20.0	21.0	9.9	16.0	16.3
3482.2018	20-18	14.0	20.0	21.0	11.8	18.0	18.3
3482.2216	22-16	17.6	23.5	24.3	9.9	16.0	16.3
3482.2218	22-18	17.6	23.5	24.3	11.8	18.0	18.3
3482.2220	22-20	17.6	23.5	24.3	14.0	20.0	21.0

3484

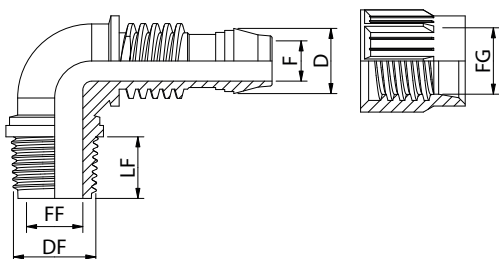

CODE	Ø	F	D	FF	DF	LF	FG
3484.016C	16-1/2"	9.9	16.0	14.0	1/2"	15.3	16.3
3484.016D	16-3/4"	9.9	16.0	18.3	3/4"	17.3	16.3
3484.018C	18-1/2"	11.8	18.0	14.0	1/2"	15.3	18.3
3484.018D	18-3/4"	11.8	18.0	18.3	3/4"	17.3	18.3
3484.020C	20-1/2"	14.0	20.0	14.0	1/2"	15.3	21.0
3484.020D	20-3/4"	14.0	20.0	18.3	3/4"	17.3	21.0
3484.022C	22-1/2"	17.6	23.5	14.0	1/2"	15.3	24.3
3484.022D	22-3/4"	17.6	23.5	18.3	3/4"	17.3	24.3

RACCORDERIA PER ALA GOCCIOLANTE "POLY"

"POLY" DRILINE FITTINGS

PER TUBI IN PE DI SPESSORE DA 0.75 A 1.40 MM (DA 30 A 55 MIL) / FOR PE PIPES WITH THICKNESS FROM 0.75 TO 1.40 MM (FROM 30 TO 55 MIL)

3490

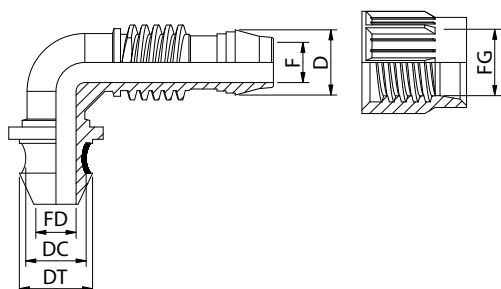

CODE	Ø	F	D	FD	DC	DT	FG
3490.0160	16-D	9.9	16.0	8.9	14.0	16.8	16.3
3490.0180	18-D	11.8	18.0	8.9	14.0	16.8	18.3
3490.0200	20-D	14.0	20.0	8.9	14.0	16.8	21.0
3490.0220	22-D	17.6	23.5	8.9	14.0	16.8	24.3

3492

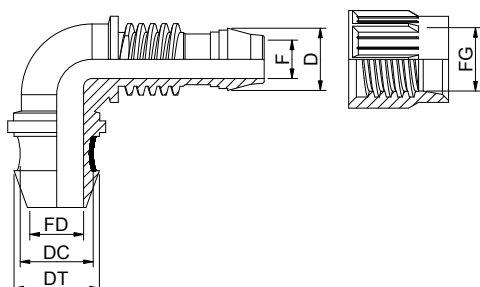

CODE	Ø	F	D	FD	DC	DT	FG
3492.0160	16-DXL	9.9	16.0	14.0	19.0	21.8	16.3
3492.0180	18-DXL	11.8	18.0	14.0	19.0	21.8	18.3
3492.0200	20-DXL	14.0	20.0	14.0	19.0	21.8	21.0
3492.0220	22-DXL	17.6	23.5	14.0	19.0	21.8	24.3

3494

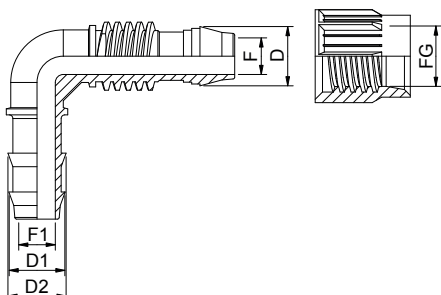

CODE	Ø	F	D	F1	D1	D2	FG
3494.1616	16-16	9.9	16.0	9.8	14.8	15.6	16.3
3494.1618	16-18	11.8	18.0	9.8	14.8	15.6	18.3
3494.1620	16-20	14.0	20.0	9.8	14.8	15.6	21.0
3494.1622	16-22	17.6	23.5	9.8	14.8	15.6	24.3
3494.2016	20-16	9.9	16.0	13.9	19.0	20.0	16.3
3494.2018	20-18	11.8	18.0	13.9	19.0	20.0	18.3
3494.2020	20-20	14.0	20.0	13.9	19.0	20.0	21.0
3494.2022	20-22	17.6	23.5	13.9	19.0	20.0	24.3
3494.2516	25-16	9.9	16.0	18.2	24.0	25.0	16.3
3494.2518	25-18	11.8	18.0	18.2	24.0	25.0	18.3
3494.2520	25-20	14.0	20.0	18.2	24.0	25.0	21.0
3494.2522	25-22	17.6	23.5	18.2	24.0	25.0	24.3

3496

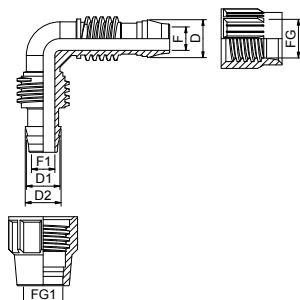

CODE	Ø	F	D	F1	D1	D2	FG	FG1
3496.1616	16-16	9.9	16.0	10.0	14.2	15.0	16.3	16.7
3496.1618	16-18	11.8	18.0	10.0	14.2	15.0	18.3	16.7
3496.1620	16-20	14.0	20.0	10.0	14.2	15.0	21.0	16.7
3496.1622	16-22	17.6	23.5	10.0	14.2	15.0	24.3	16.7
3496.2016	20-16	9.9	16.0	14.0	18.3	19.1	16.3	20.7
3496.2018	20-18	11.8	18.0	14.0	18.3	19.1	18.3	20.7
3496.2020	20-20	14.0	20.0	14.0	18.3	19.1	21.0	20.7
3496.2022	20-22	17.6	23.5	14.0	18.3	19.1	24.3	20.7
3496.2516	25-16	9.9	16.0	18.3	23.1	23.9	16.3	25.7
3496.2518	25-18	11.8	18.0	18.3	23.1	23.9	18.3	25.7
3496.2520	25-20	14.0	20.0	18.3	23.1	23.9	21.0	25.7
3496.2522	25-22	17.6	23.5	18.3	23.1	23.9	24.3	25.7